

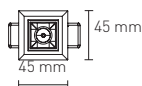

# NEXIA BOXET

Modular recessed downlight with  
UGR<13. Available in one, two, five  
and ten modules.



19101-		Colour	CRI / Temp.	Angle	Led	Dimming	Class		
0	White	C	830	1	12°	0	255lm / 2 W	-	II
1	Black	N	840	3	34°				
		E	930	4	48°				
		F	940						

37g	38x38	1	20	CRI 80/90	50.000 h	230 V	DRIVER	LED
-----	-------	---	----	-----------	----------	-------	--------	-----

## DESCRIPTION

Small recessed high output fixture, which allows to achieve a minimum impact in your projects.  
BOXET provides you the best light output for projects that require a high visual comfort.

UGR <13

## INSTALLATION

Modular recessed downlight with a diameter of 38x38mm.

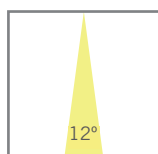

12°

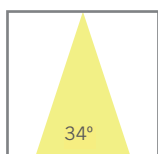

34°

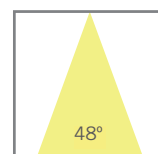

48°

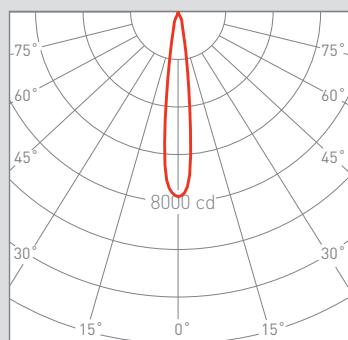

cd / Klm  
— c0 - 180 — c90 - 270  
n = 85%

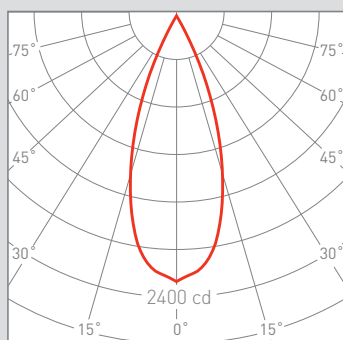

cd / Klm  
— c0 - 180 — c90 - 270  
n = 89%

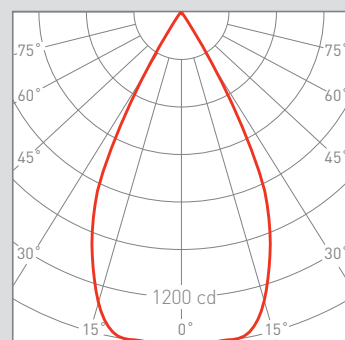

cd / Klm  
— c0 - 180 — c90 - 270  
n = 88%

QUALITY CERTIFICATES:

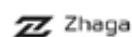



# NEXIA BOXET

Modular recessed downlight with  
UGR<13. Available in one, two, five  
and ten modules.

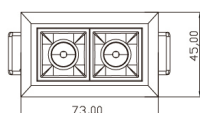
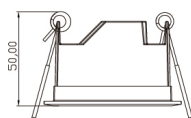

19102-		Colour	CRI / Temp.	Angle	Led	Dimming	Class		
0	White	C	830	1	12°	0	500lm / 4 W	-	II
1	Black	N	840	3	34°				
		E	930	4	48°				
		F	940						

47g	65x38	1	20	IP	CRI 80/90	50.000 h	230 V	DRIVER	LED
-----	-------	---	----	----	-----------	----------	-------	--------	-----

## DESCRIPTION

Small recessed high output fixture, which allows to achieve a minimum impact in your projects.  
BOXET provides you the best light output for projects that require a high visual comfort.

UGR <13

## INSTALLATION

Modular recessed downlight with a diameter of 65x38mm.

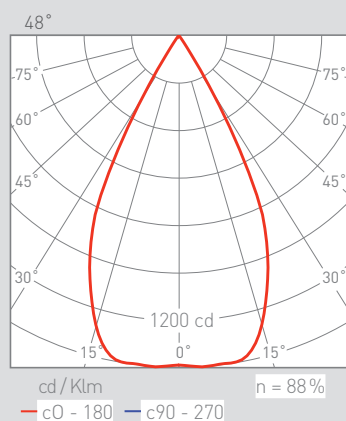
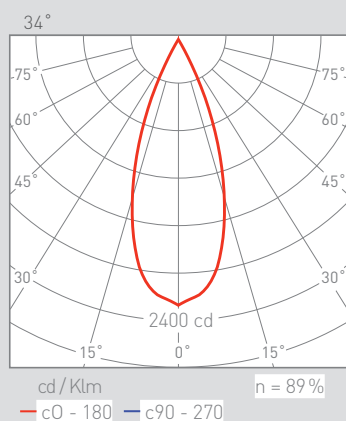
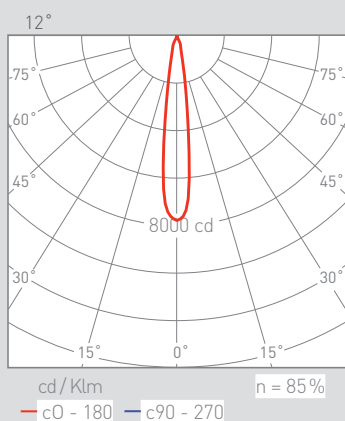
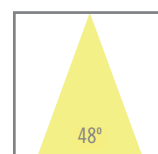
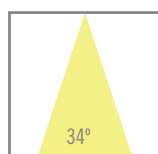
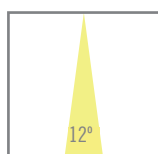

QUALITY CERTIFICATES:

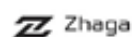



# NEXIA BOXET

Modular recessed downlight with  
UGR<13. Available in one, two, five  
and ten modules.

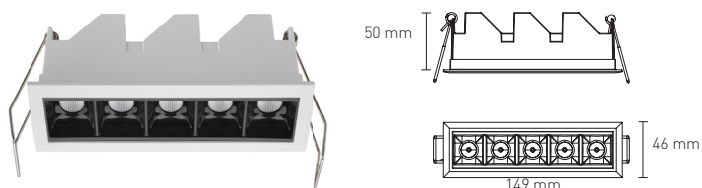

19105-		Colour	CRI / Temp.	Angle	Led	Dimming	Class			
0	White	C	830	1	12°	1	1240lm / 10 W	D	Dali	II
1	Black	N	840	3	34°					
		E	930	4	48°					
		F	940							

80g	138x38	1	20	IP	CRI 80/90	50.000 h	230 V	DRIVER	LED
-----	--------	---	----	----	-----------	----------	-------	--------	-----

## DESCRIPTION

Small recessed high output fixture, which allows to achieve a minimum impact in your projects.  
BOXET provides you the best light output for projects that require a high visual comfort.

UGR <13

## INSTALLATION

Modular recessed downlight with a diameter of 138x38mm.

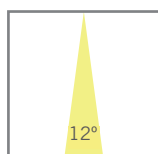

12°

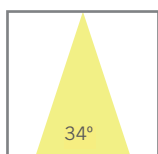

34°

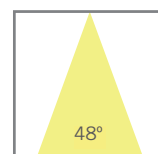

48°

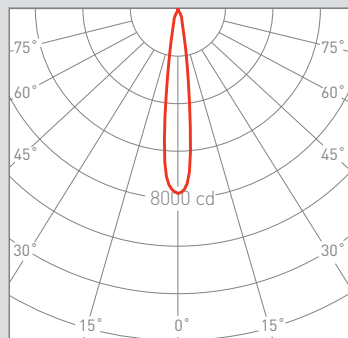

cd / Klm      n = 85%  
— c0 - 180    — c90 - 270

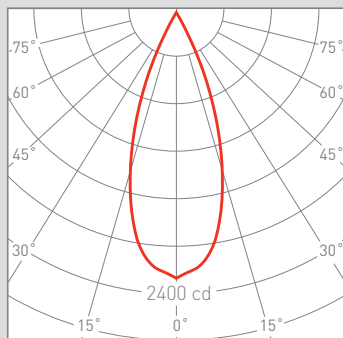

cd / Klm      n = 89%  
— c0 - 180    — c90 - 270

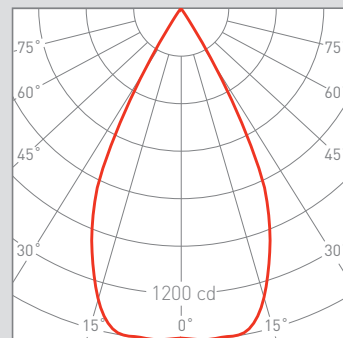

cd / Klm      n = 88%  
— c0 - 180    — c90 - 270

QUALITY CERTIFICATES:

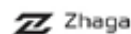



# NEXIA BOXET

Modular recessed downlight with  
UGR<13. Available in one, two, five  
and ten modules.

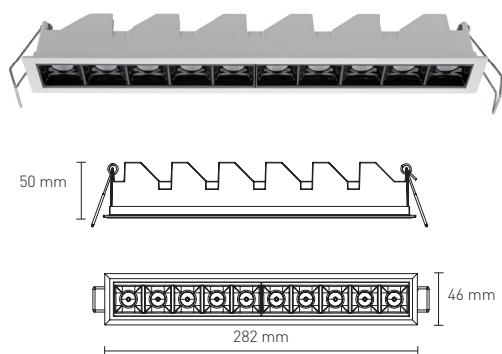

19110-		Colour	CRI / Temp.	Angle	Led	Dimming	Class			
0	White	C	830	1	12°	1	2440lm / 20 W	D	Dali	II
1	Black	N	840	3	34°					
		E	930	4	48°					
		F	940							

141g	217x38	1	20	IP	CRI 80/90	50.000 h	230 V	DRIVER	LED
------	--------	---	----	----	-----------	----------	-------	--------	-----

## DESCRIPTION

Small recessed high output fixture, which allows to achieve a minimum impact in your projects.  
BOXET provides you the best light output for projects that require a high visual comfort.

UGR <13

## INSTALLATION

Modular recessed downlight with a diameter of 217x38mm.

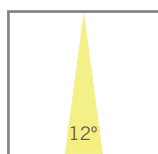

12°

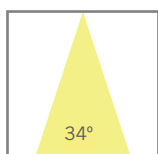

34°

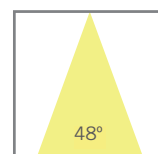

48°

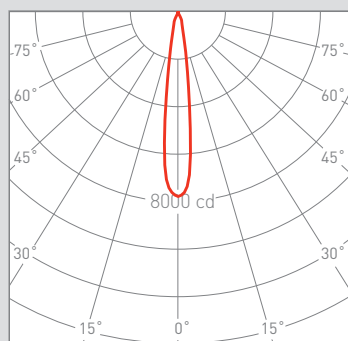

cd / Klm      n = 85%  
— c0 - 180 — c90 - 270

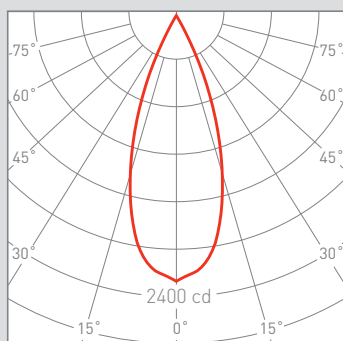

cd / Klm      n = 89%  
— c0 - 180 — c90 - 270

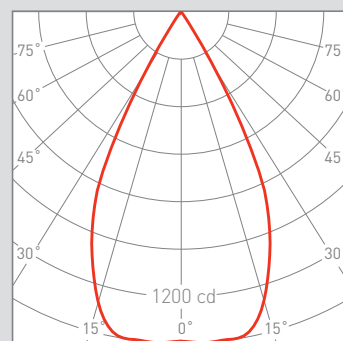

cd / Klm      n = 88%  
— c0 - 180 — c90 - 270

QUALITY CERTIFICATES:

